

## Solenoid Worksheet

1. Two of the following diagrams correctly represent the magnetic field created by an electric current flowing through a solenoid. Which two diagrams are they?

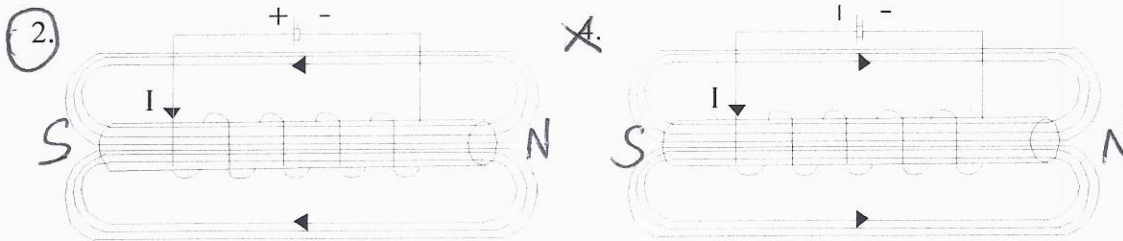

2. In the solenoid below, which terminal (A or B) of the power supply is positive, and which is negative?

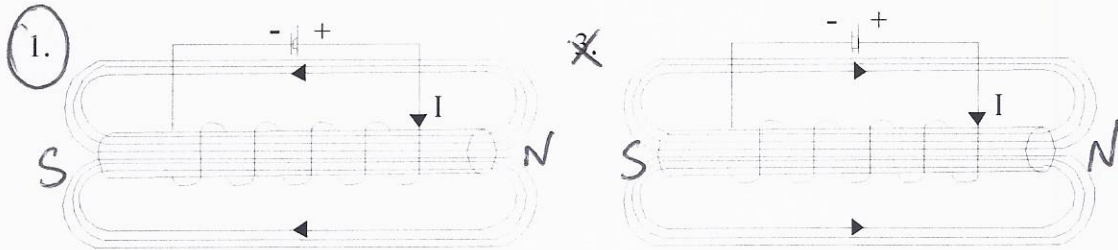
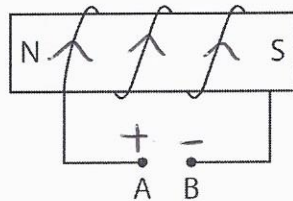

3. An electric current flows through a solenoid. Which diagram correctly illustrates the magnetic field produced by this solenoid?

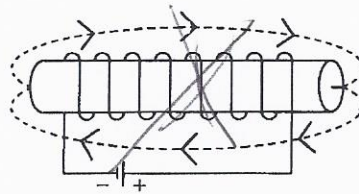
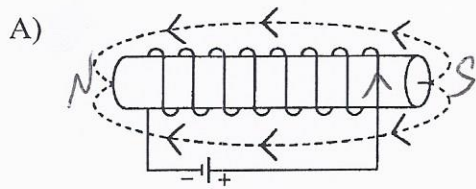

B)

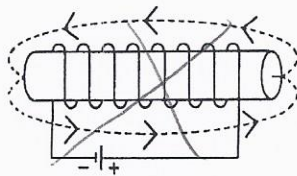

D)

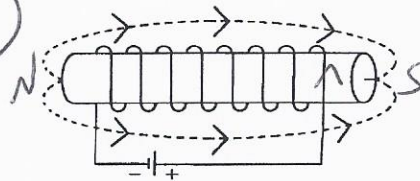

4. A bar magnet is brought close to a current-bearing solenoid. In which one of the following situations will there be repulsion?

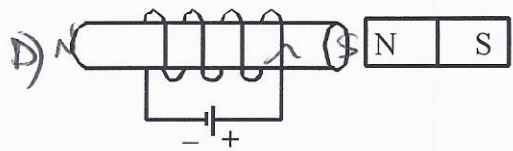
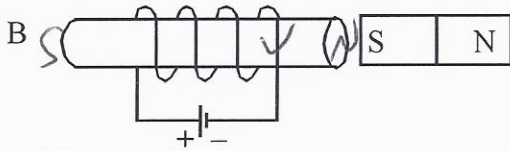
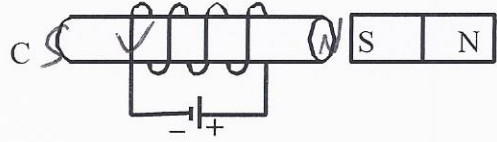
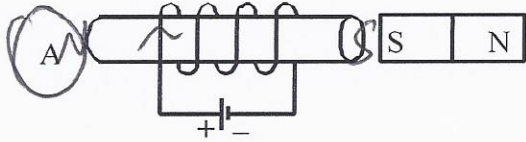

5. Which of the following diagrams correctly represents the magnetic lines of force between two solenoids?

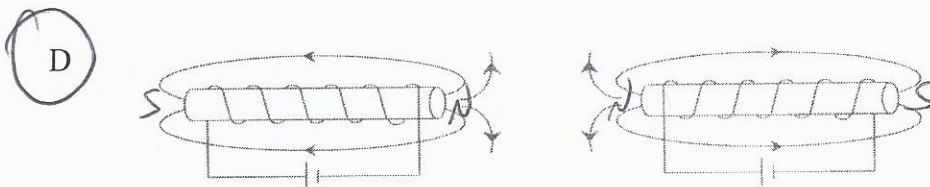
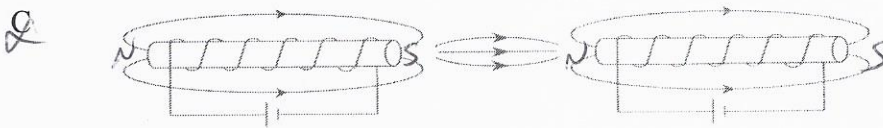
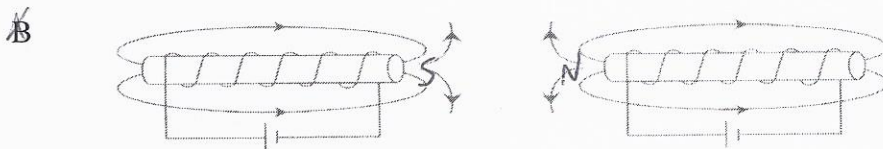
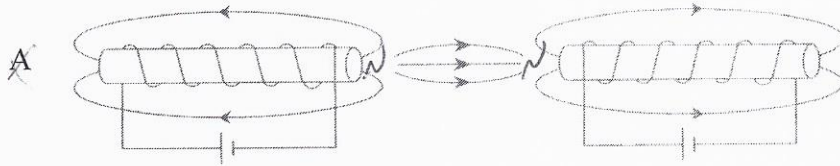

6. On each diagram in your answer booklet, draw the magnetic lines of force that are present and indicate the magnetic poles when a current flows through the two solenoids.

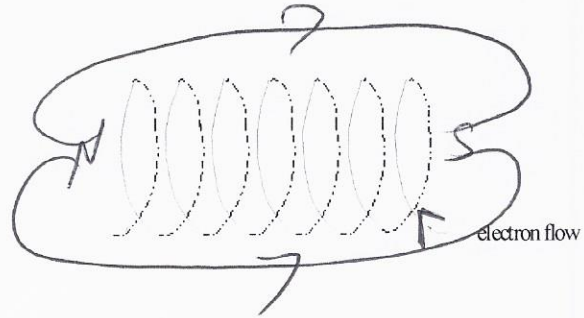
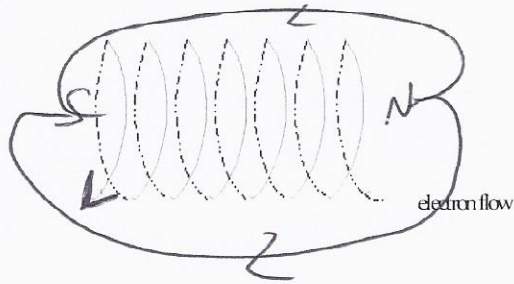

7. Electric current flows through three solenoids aligned side by side.

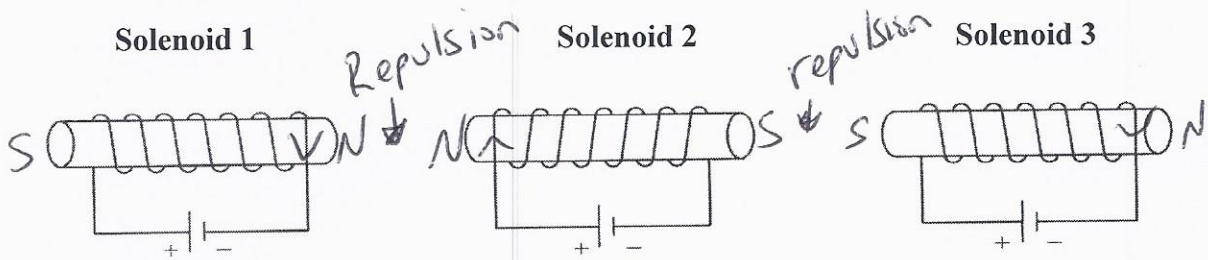

Determine if there will be attraction or repulsion between the three solenoids. Justify your answer by filling in the information on the solenoids.

8. A compass is placed in a magnetic field. Which of the following diagrams shows the compass needle pointing in the correct direction?

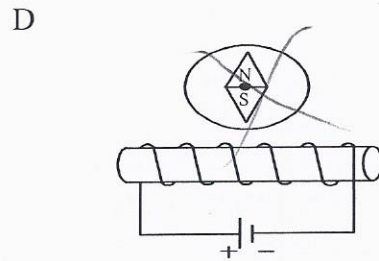
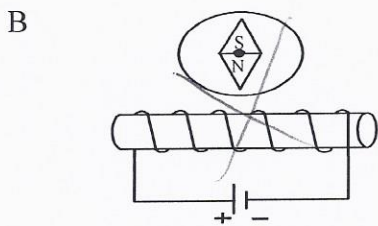
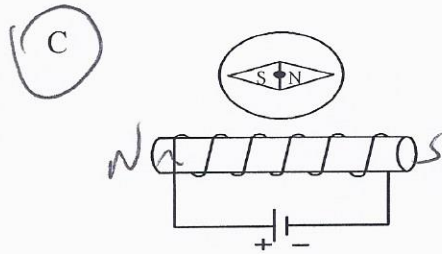
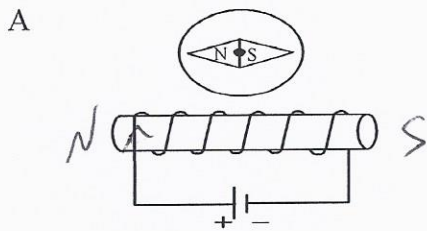

9. Draw the magnetic field lines and put in the current direction for each of the solenoids.

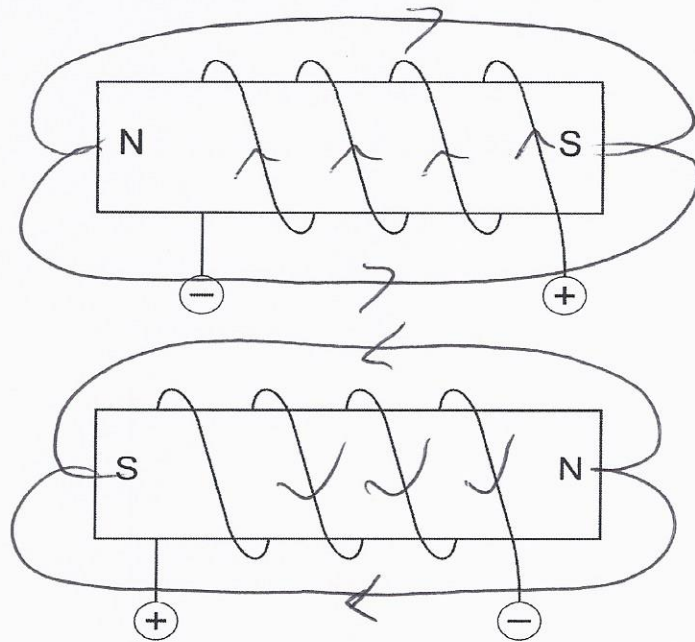

10. A compass is placed at one end of a solenoid. In which illustration is the compass needle pointing in the right direction? Justify your choice.

A)

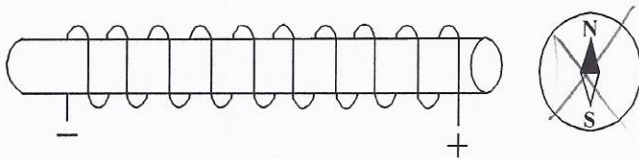

B

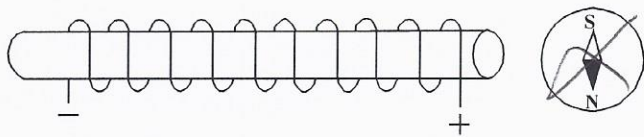

C

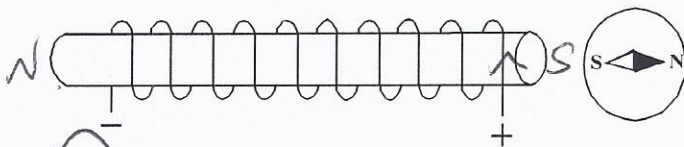

(D)

